

## Fan Performance Characteristics of Axial Fans

### Introduction

There are two general classifications of fans: the centrifugal or radial flow fan (see FE-2400) and the propeller or axial flow fan. In the broadest sense, what sets them apart is how the air passes through the impeller.

The propeller or axial flow fan propels the air in an axial direction (Figure 1a) with a swirling tangential motion created by the rotating impeller blades.

In a centrifugal fan the air enters the impeller axially and is accelerated by the blades and discharged radially (Figure 1b).

Figure 1a. Axial Flow

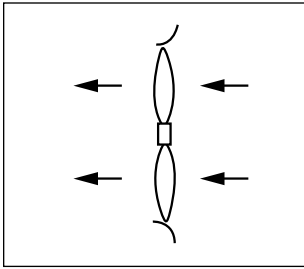
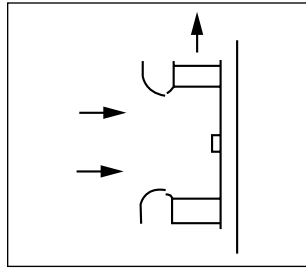

Figure 1b. Centrifugal Flow



The axial flow fan increases the air velocity through rotational or tangential force which produces velocity pressure (VP), kinetic energy, with a very small increase in static pressure (SP), potential energy.

The centrifugal fan induces airflow by the centrifugal force generated in a rotating column of air producing potential energy (SP) and also by the rotational (tangential) velocity imparted to the air as it leaves the tip of the blades producing kinetic energy (VP).

### Axial Flow Fans

Axial flow fans come in many variations that all have one thing in common: they rotate about their axis and they move a column of air parallel to that axis.

The axial fan is commonly found in residential and commercial applications where emphasis is on moving large volumes of air against relatively low pressures as economically (low first cost) as possible. The axial fan is also finding greater acceptance in industrial applications as alternative equipment to the more expensive centrifugal (radial flow) fans.

While residential applications are concerned primarily with creature comfort, commercial and industrial requirements are expanded to include ventilation for process as well as worker comfort.

There are many variations of axial flow fans, all of which have performance characteristics of the three basic types: propeller fans, tubeaxial fans and vaneaxial fans.

### Propeller Fans

Propeller fans can be placed in two categories:

1. Air Circulator or Free Fans — A free fan is one that rotates in a common unrestricted air space. Examples of free fans include ceiling fans, desk fans, pedestal fans, and wind fans. With the exception of the wind fans, most of these fans are more decorative than functional. Low tech, low cost designs function to move and stir the air, but are not necessarily the most efficient of designs.
2. Orifice Panel or Orifice Ring Fans — These are the fans most associated with applications referred to as ventilating fans. There are many variations of these arrangements, some with long shaft extensions, direct connection to a motor, arranged with bearings and sheaves for belt drive and close coupled belted arrangements. These fans are designed to transfer air from one large space to another.

Axial panel and ring fan design must respond to many variables that affect:

- Materials of construction of the panel or ring
- Materials of construction of the impeller
- Type of impeller blades
- Number of impeller blades
- Hub configuration

For example, typically residential and commercial panel and ring fans are constructed using shallow drawn lightweight metal or plastic orifices. Impellers for these fans are also of lightweight construction having from two to six wide, single thickness, sometimes overlapping blades designed for low cost, low speed and low pressure operation (Figure 2.)

These fans generally operate against pressures below  $\frac{1}{2}$ " water gauge, are relatively inefficient and have a steeply rising power curve (Figure 3) which presents the danger of serious motor overloading in the event the air passages in the fan system become accidentally blocked.

Figure 2. Typical 4-Bladed Commercial Impeller

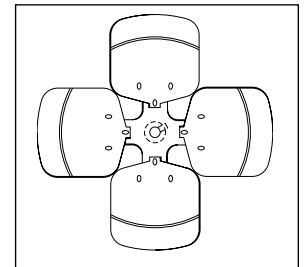
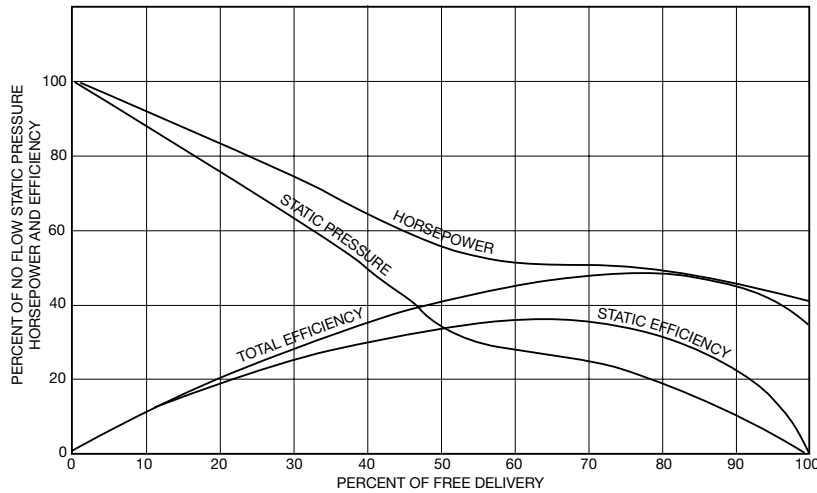

Figure 3. Characteristic Performance of a Commercial Panel Fan with a Wide Single Thickness 5-Blade Impeller



Like most axial fans, the static pressure curve exhibits a dip (stall or surge region) where unstable operation occurs. A fan operating in this region will experience pulsating behavior and increased noise levels. Extended operation in this area will result in severe damage to the structure and the impeller. A fan should be selected to operate comfortably to the right of this stall region. In the case of our example, the fan should be selected to operate at 70% to 100% of free delivery. If this is not possible, a smaller fan should be chosen for the application.

On the other hand, a typical industrial orifice panel fan is constructed of heavier gauge materials incorporating a deep drawn venturi (Figure 4). These fans use stronger, more efficiently designed cast aluminum airfoil or cambered stamped steel impellers (Figures 5 and 6). While normally designed for pressures up to 1" of water, these fans can be designed to reach 2" to 3" of static pressure.

The designer strives for a fan to have an almost flat power curve characteristic. Generally speaking, fan impellers with two to eight narrow-to-medium width blades have what is called a "flat" power curve. The power curve rises only slightly from free air to about mid-range (Figure 7) and then drops slightly with an upswing near the condition of no flow. Increasing the number of blades will usually decrease the free air volume and increase its ability to work against pressure.

Compare the curves in Figures 3 and 7. Note the increased operating range (55% to 100%) and higher

Figure 4. Direct Drive Industrial Panel Fan With Deep Draw Venturi

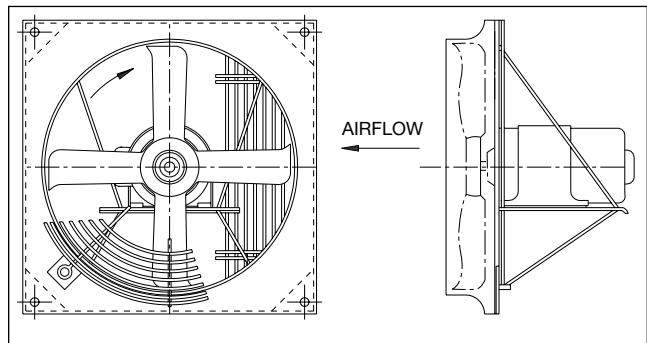

Figure 5. Medium Width Cast Aluminum Airfoil Impeller

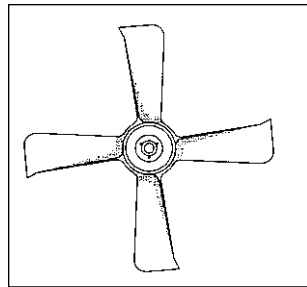

Figure 6. Medium Width Stamped Steel Impeller

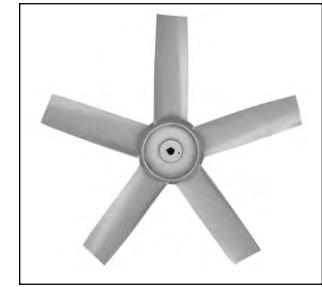
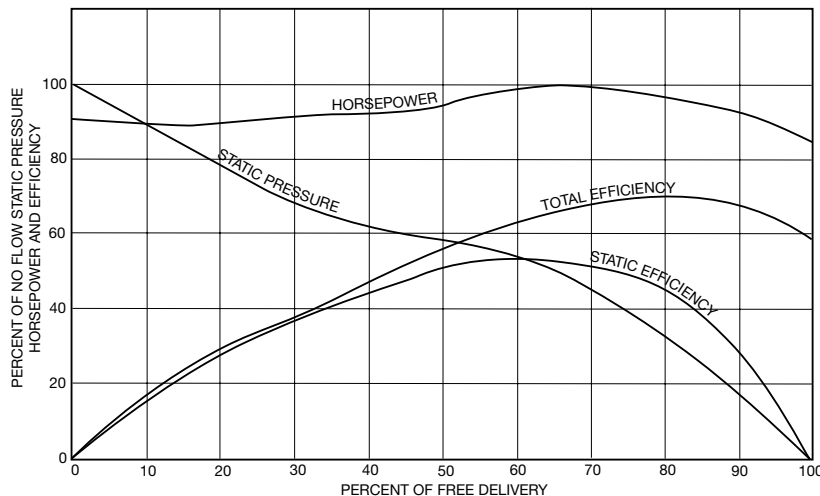

Figure 7. Characteristic Performance of an Industrial Panel Fan with a Medium Width 4-Blade Airfoil Impeller



static pressure capability of the industrial panel fan over the commercial fan. Also note the higher efficiencies attained by this fan. Now compare the industrial panel fan performance (Figure 7) against a similar size tubeaxial fan (Figure 10). We can see that there is a negligible performance difference between a well designed industrial panel fan and a tubeaxial fan.

As mentioned previously, specialty panel fans can be designed to work against pressures of 2" to 3" of water. In addition to additional blades these impellers also have higher "hub-to-tip" ratios (the outside hub diameter divided by propeller diameter) than typical panel fan impellers. A low pressure commercial impeller (Figure 2) might have a hub-to-tip ratio in the range of 0.15, while a well designed industrial impeller (Figures 5 and 6) is in the range of 0.25. A typical higher pressure impeller (Figure 8) will have a hub-to-tip ratio of 0.4 or greater.

Another popular speciality fan utilizes a reversible propeller, in a double orifice panel. Designed with a hub-to-tip ratio of 0.25, this "S" shaped blade is capable of moving the same airflow at the same horsepower, in either direction, with the flip of a switch. This propeller exhibits a static pressure curve similar to Figure 7, combined with a horsepower curve similar to Figure 3.

## Tubeaxial Fans

The tubeaxial fan (Figure 9) is a propeller fan mounted in a cylindrical tube or duct and is often called a duct fan. Fans of this type employ a variety of impeller designs similar to those already described under the industrial panel fan. The tubeaxial fan can operate in pressure ranges up to 4" water gauge primarily because its strong construction allows for higher speeds and horsepower.

The performance characteristics of the tubeaxial fan are very similar to those previously shown for the industrial panel fan. The performance curve (Figure 10) is for a tubeaxial fan using the same impeller that was used in the industrial panel fan (Figure 7). Generally speaking, the tubeaxial fan will develop slightly better pressure characteristics than a similar well designed panel fan.

Tubeaxial fans are designed for use in ducted applications. Much more versatile than the panel fan by virtue of their construction, they are most adaptable to ventilation of industrial processes. They can be built of materials which will stand up under light abrasion,

Figure 8. 6-Blade Impeller for Medium Low Pressure Applications

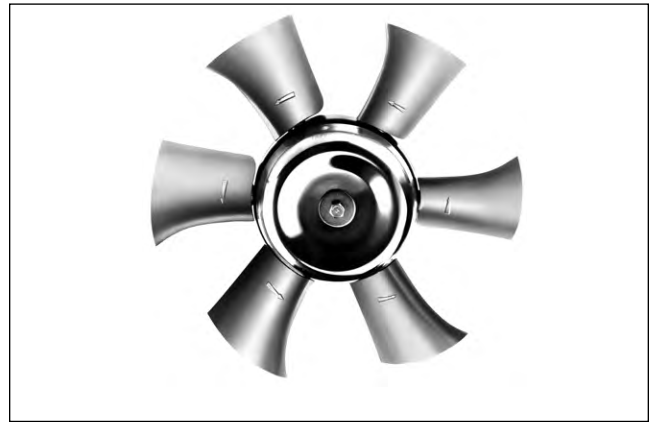
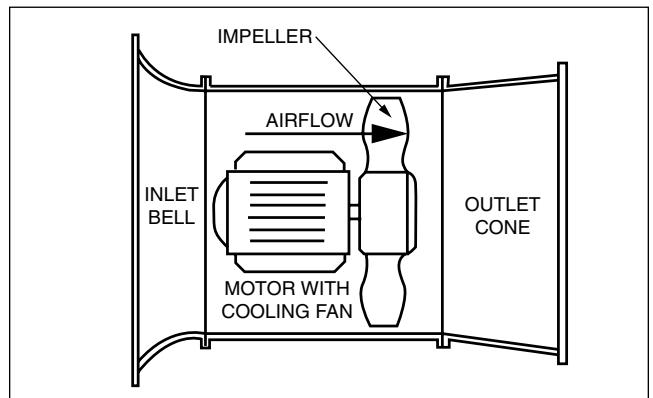
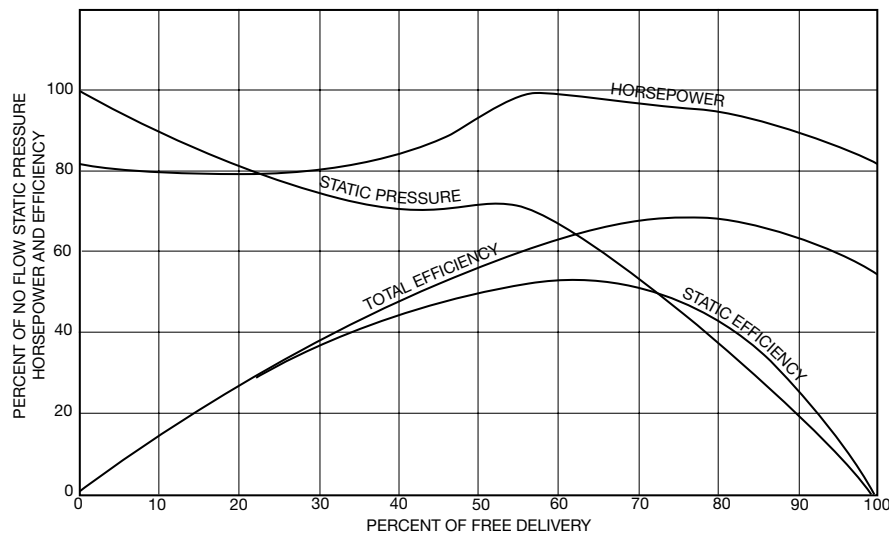

Figure 9. Direct Drive Tubeaxial Fan



temperatures up to 600°F, or air heavily contaminated with corrosive chemicals or explosive vapors. They can be mounted in parallel for higher airflows or they can be staged in series to increase their pressure capabilities. Also, as mentioned under the panel fans, using larger hub-to-tip ratio impellers increases the tubeaxial fan's ability to work against pressure for a given speed or conversely enables the fan to work against the same pressure at a lower speed.

Figure 10. Characteristic Performance of a Tubeaxial Fan with a Medium Width 4-Blade Airfoil Impeller



## Vaneaxial Fans

The vaneaxial fan (Figure 11) is a variation of the duct fan design which operates in the medium-to-high pressure ranges. Two to 10 inches water gauge is the expected pressure range for a single stage fan.

The performance of the vaneaxial fan (Figure 12) shows the pressure curve to rise steeply from free delivery to a maximum point and then dip sharply into stall. From the bottom of the stall range the pressure rises again to a higher pressure value at the point of no flow. The increased operating pressure characteristic of the vaneaxial fan is the combined result of impeller design and the guide vanes.

The guide vanes are usually located at the discharge of the impeller. The function of the vanes is to recover the energy of rotation and convert this into useful work. The efficiency of the vaneaxial fan rises to a maximum near the midrange peak pressure point. Its efficiency is higher than the efficiency of other types of axial fans, but the horsepower characteristic is not as flat as that of the industrial panel or tubeaxial fans. The power rises from free delivery to the mid-range peak pressure, dips similarly as does the static pressure curve, and then rises again toward the point of no flow.

In designing a system for the vaneaxial fan, it is necessary to be sure that the point of operation is to the right of the dip in the performance curve, but not too far from the peak pressure point to take advantage of maximum efficiency. When operating vaneaxial fans in parallel, care should be taken to ensure that the flow is divided equally. Vaneaxial fans work well in series, either as two stages in a common housing or as two separate fans installed end to end.

One valued feature of the vaneaxial fan is its ability to allow pitch changes for controlling air volumes, either through in-flight adjustable or manually adjustable

Figure 11. Belt Driven Vaneaxial Fan

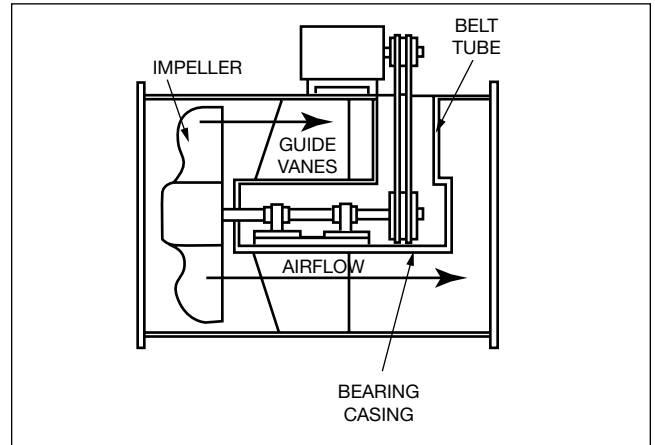

versions. The adjustable pitch versions are limited to clean air applications; however, fans with cast solid impellers can be designed to handle high temperatures and chemical contaminated air. Vaneaxial fans are not recommended for applications containing abrasives, dust, stringy materials or overspray since buildup on the guide vanes will decrease fan performance.

## Conclusion

Propeller fans have many advantages over other forms of air moving devices and the recognition of these has brought about rapid progress in their development and use. Among the main advantages of propeller fans are their high capacity-to-weight ratio, the inline flow design making installation in ducts simple and the broad range of high efficiency performance.

Figure 12. Characteristic Performance of a Vaneaxial Fan with a Medium Width 7-Blade Airfoil Impeller

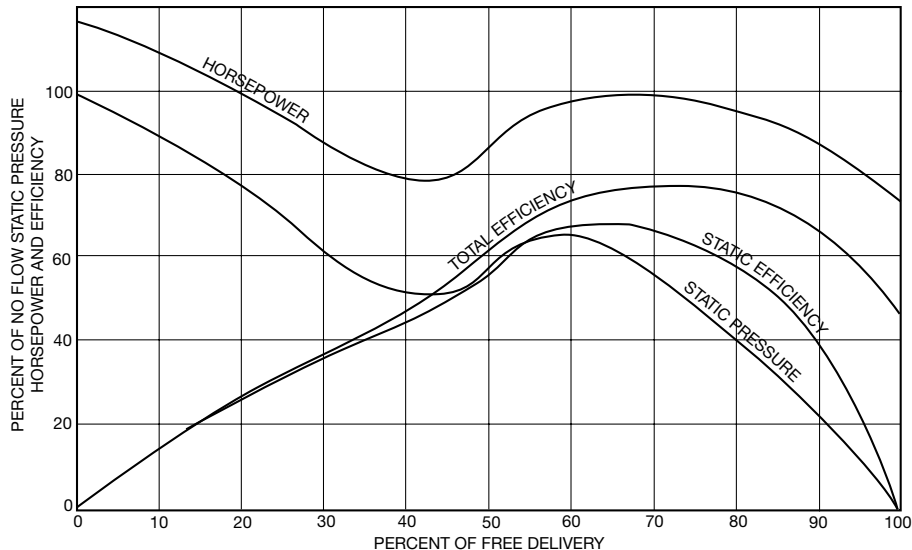

TWIN CITY FAN & BLOWER | [WWW.TCF.COM](http://WWW.TCF.COM)

5959 TRENTON LANE N. | MINNEAPOLIS, MN 55442 | PHONE: 763-551-7600 | FAX: 763-551-7601